

VW MiniLogger

52613399

Copyright ©2007 DGSi. All Rights Reserved.

This equipment should be installed, maintained, and operated by technically qualified personnel. Any errors or omissions in data, or the interpretation of data, are not the responsibility of Durham Geo Slope Indicator (DGSi). The information herein is subject to change without notification.

This document contains information that is proprietary to DGSi and is subject to return upon request. It is transmitted for the sole purpose of aiding the transaction of business between DGSi and the recipient. All information, data, designs, and drawings contained herein are proprietary to and the property of DGSi, and may not be reproduced or copied in any form, by photocopy or any other means, including disclosure to outside parties, directly or indirectly, without permission in writing from DGSi.

SLOPE INDICATOR

12123 Harbour Reach Drive
Mukilteo, Washington, USA, 98275
Tel: 425-493-6200 Fax: 425-493-6250
E-mail: solutions@slope.com
Website: www.slopeindicator.com

Contents

Introduction	1
Installing the Manager Program	2
Connecting to the MiniLogger.....	4
Setting Up	8
Data Logging	12
Retrieving Data	14
About Radio MiniLoggers	18
Installing Base Station Software ...	19
Making a Radio ID List.....	22
Connecting to Radio MiniLoggers .	25

Introduction

- The MiniLogger System** The VW MiniLogger is a compact datalogger designed to monitor a single VW sensor, such as a piezometer, crackmeter, strain gauge, or displacement sensor.
- MiniLogger Manager for Windows is included with the VW MiniLogger. It is used to program the MiniLogger and also to retrieve the readings that the MiniLogger has recorded.
- A wireless option can be added to the MiniLogger. The MiniLogger can then be set up and programmed remotely by a PC connected to a base-station radio.
- Chapters in this Manual**
- Installing the Manager Program** tells how to install the MiniLogger Manager software on your PC.
 - Connecting to the MiniLogger** tells how to connect your PC to the MiniLogger with a serial cable.
 - Setting Up** tells how to set reading intervals and other functions of the MiniLogger.
 - Data Logging** tells how to connect a sensor to the logger and start data logging.
 - Retrieving Data** tells how to retrieve data from the logger and save it on your PC.
 - About Radio MiniLoggers** provides a brief overview of the wireless system.
 - Installing Base Station Software** tells how to install drivers for wireless communications.
 - Entering Radio IDs** tells how to make a list of your Radio MiniLoggers.
 - Connecting to Radio MiniLoggers** tells how to establish a radio link between your PC and the Radio MiniLogger.

Installing the Manager Program

Introduction The Manager program is used to program the MiniLogger and to retrieve stored data. You can download the most recent version of the program from www.slopeindicator.com or install the program from a Resource CD.

Download the Manager Program If you have a good internet connection, we recommended that you download the MiniLogger Manager program. The Slope Indicator website always has the most recent version. If you don't have a good internet connection, install from the Resource CD, as explained on the next page.

1. Start your internet browser. Click in the address field, enter www.slopeindicator.com, and click Go. When the website appears:
 2. Click on Downloads, then click on Software.
 3. Read the download instructions at the top of the page, then click on Click on "VW MiniLogger 2" to start the download.
 4. *Double-click on the downloaded file, which is called "setupvwml2.msi."
 5. Follow on-screen setup instructions. Afterwards, you will find a shortcut named VW MiniLogger 2 on your start menu. The actual path to your program is normally C:\Program Files\VWMiniLooger 2\VWML2.exe.
- * If your PC is running Windows 95 and 98, you may have to download and install the "Microsoft Installer." It is available on the Slope Indicator website.

Updating the Manager Program

1. Follow the steps above to download the most recent version of the Manager program.
2. When you double-click on the downloaded file (setupvwml2.msi), a dialog asks if you want to modify, repair, or remove the file. Choose remove. Windows then removes your old Manager program (but not any data).
3. Next, double-click on "setupvwml2.msi" again. This time it will install the updated version.

Install from the Resource CD

If you don't have a good internet connection, it will be more convenient to install the program from the Resource CD that was included with the MiniLogger.

1. Close all programs and insert the Resource CD.
2. Wait for your browser to start. If necessary, eject and reinsert the CD or start your browser, and navigate to the CD, and open `cdmenu.html`.
3. Choose Software.
4. Choose VW MiniLogger Manager 2.
5. A dialog appears. Choose "Open." On older browsers, choose "Run this program from its current location."
6. Follow the on-screen directions for the setup program.

Connecting to the MiniLogger

Overview This chapter tells how connect a PC to the MiniLogger using a serial cable.

Power Up the MiniLogger The MiniLogger requires two D-cell batteries. Alkaline batteries normally provide about three months of service. Actual battery life depends on the temperature, the reading rate, whether or not a radio is used, and how frequently data is retrieved.

1. Connect the wires of the battery holder to the terminal post, if necessary.
2. Orient and insert the batteries as shown on the battery holder.
3. The MiniLogger takes a reading immediately and then waits for its next scheduled reading.

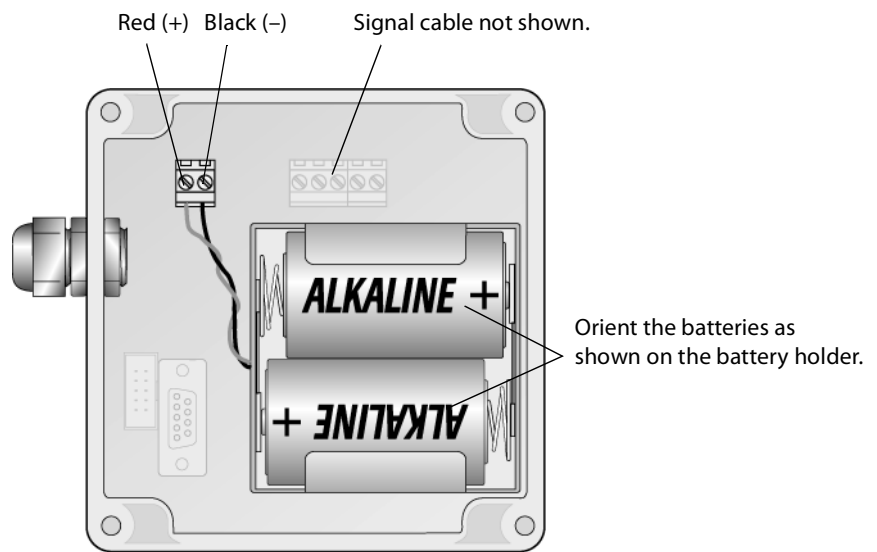

Connect by Serial Cable

A serial cable is supplied with the MiniLogger. It is a “modem cable” with straight-through wires. (Null-modem cables will not work).

1. Find your PC's serial port. Look for a 9-pin connector.

Some newer computers do not have a serial port. In that case, a USB to serial adaptor or a PC card is required. See troubleshooting later in this chapter.

2. Connect one end of the interface cable to the PC's serial port and the other end of the cable to the MiniLogger's serial port.

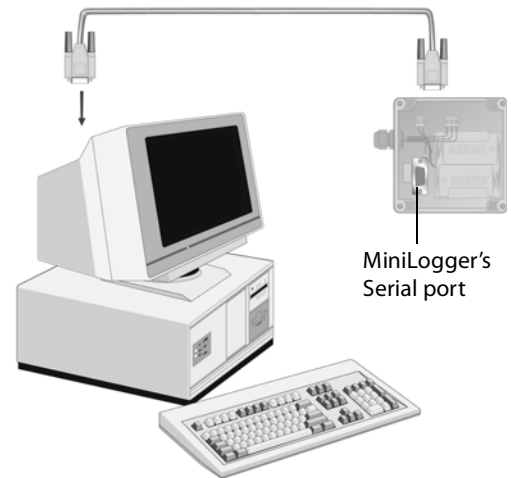

Start the MiniLogger Manager Program.

1. Click on Start and Choose Programs or All Programs.
2. Point at VW MiniLogger 2.
3. Double-click on VW MiniLogger 2.
4. Click on the Edit Settings button.

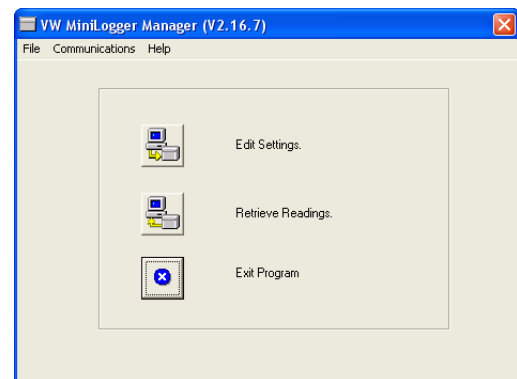

5. You should see a screen similar to this.

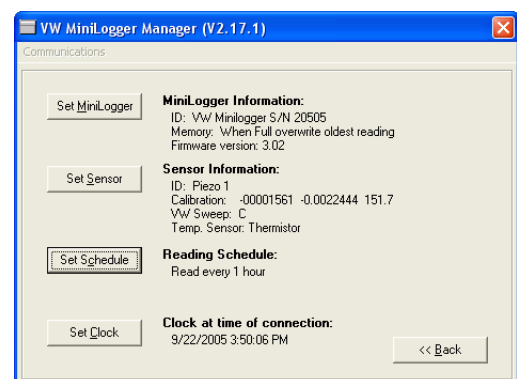

Troubleshooting Serial Connections

If you see an error message, click OK to clear the message, and then:



- Check that the cables are firmly connected to MiniLogger and computer.
- Check the connection type, as explained below.
- Change the comm port, as explained below.
- Get a USB adapter, if necessary, as explained on the next page.

Check Connection Type

1. Click “Communications” on the menu bar.
2. Confirm that “Serial Cable” is selected. If it was not selected, select it, click OK, and try connecting again.

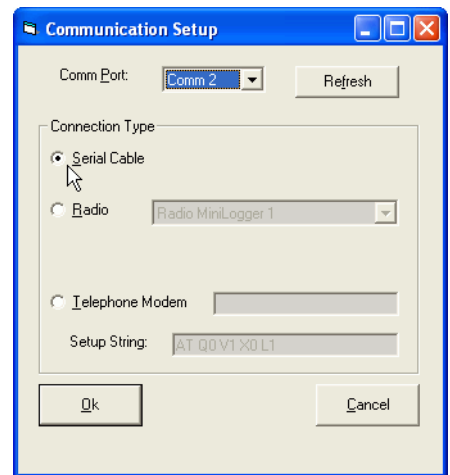

Change the Comm Port

1. Click Communications.
2. Click the Refresh Button. The Manager program then creates a list of available Comm ports.
3. Choose a different Comm port from the drop list and click OK.
4. If there is only one choice on the Comm Port list, then some other device probably has control of the serial port.

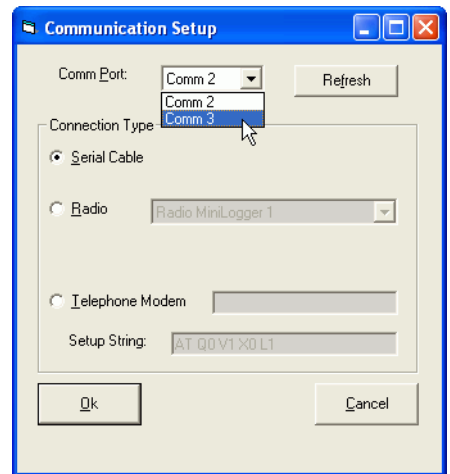

Do you have a PDA? Sometimes PDA synchronization software takes control of the serial port. In this case, turn off the PDA program, and then try connecting to the MiniLogger again.

Troubleshooting continued

Can't find a serial port? Some computers have only USB ports. In this case, you must use a USB-to-Serial adaptor or a PC card (PCMCIA card) to connect to the MiniLogger.

USB to Serial Adapters

USB-to-serial adapters are less expensive and are available in computer stores and office-supply stores. In the package, you will find driver software and instructions. Follow the instructions exactly.

The driver will create a new Comm port. When you start the Manager program, and click communications, you should see the new port when your USB cable is plugged in. If you do not see the port, click the refresh button.

If the adapter does not work when you try it, download and install the latest driver from the manufacturer's website. There are usually instructions with the adaptor that tell how to do this. We find that most adapters work fine when updated drivers are installed.

PC Card Serial Port

If your portable computer has a PC Card slot, you can use a PC card to provide a serial interface card. PC cards are typically more expensive than the adapters above, but the PCMCIA standard is fairly mature and the card is likely to work well.

Setting Up

- Preparations**
1. Check that the MiniLogger's batteries are in place.
 2. Connect the MiniLogger to the PC.

- Edit Settings**
1. Click "Edit Settings." The Manager program displays the settings screen.
 2. Click the buttons to display the various setup screens. For example, click on Set Schedule to set the MiniLogger's reading schedule. Settings are explained below.

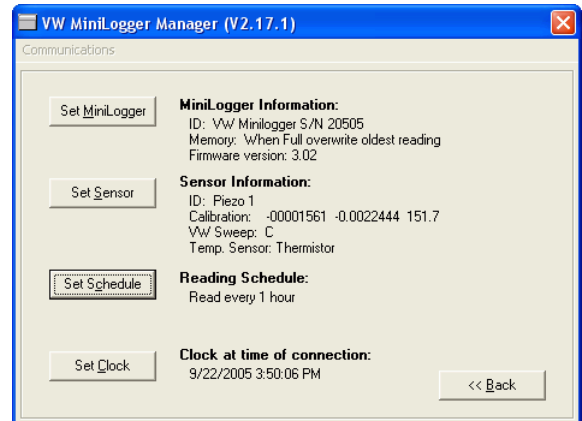

Set MiniLogger Click "Set MiniLogger."

MiniLogger ID: Enter an identifier for the MiniLogger.

When Logger Memory is Full:

Choose either stop recording or continue recording.

In the Stop mode, the MiniLogger stops recording when its memory is full. It will not record again until you retrieve the data and clear its memory.

In the Continue mode, the MiniLogger continues recording readings when its memory is full. It overwrites the earliest readings with the most recent readings.



Set Sensor

Click the Set Sensor button to enter the sensor serial number, the sweep frequency, and sensor calibration factors.

Sensor SN: Enter the serial number of the sensor or some other designation for the sensor.

Later when you retrieve data and want to save it to disk, the Sensor SN entry will be suggested as a file name.

Sweep Frequency: Choose a sweep frequency that matches the frequency range of your sensor. "C" is the most commonly used sweep. See the table on the next page to find the sweep frequency suggested for your sensor.

Use ABC / TI factors: Click the radio button for ABC or TI factors. These factors are used to convert Hz readings to kPa or psi. TI factors integrate temperature readings to automatically correct for temperature effects. See the sensor calibration sheet to see how the factors are applied.

Calibration Factors: The actual calibration values are found on the sensor calibration sheet. Each sensor has unique factors, so check that the serial number on the calibration record matches the serial number of the sensor connected to the MiniLogger.

The Manager program applies these factors to readings that it retrieves from the MiniLoggers. The resulting data file will contain both the original Hz values and also the calculated values.

RTD or Thermistor: Choose Thermistor or RTD. Most VW sensors use thermistors.

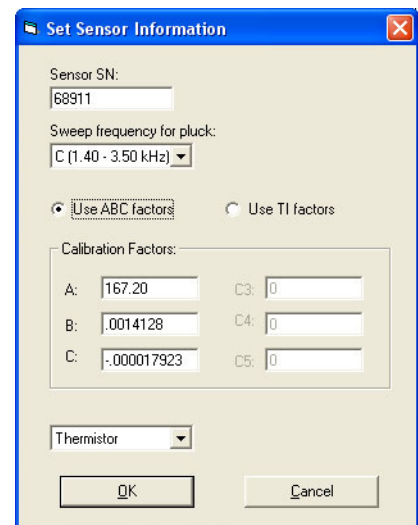

The screenshot shows the 'Set Sensor Information' dialog box. The 'Sensor SN' field contains '68911'. The 'Sweep frequency for pluck:' dropdown is set to 'C (1.40 - 3.50 kHz)'. The 'Use ABC factors' radio button is selected. The 'Calibration Factors' section contains the following values: A: 167.20, B: .0014128, C: -.000017923, C3: 0, C4: 0, C5: 0. The 'Thermistor' dropdown is selected. The 'OK' and 'Cancel' buttons are at the bottom.

Using ABC Calibration Factors

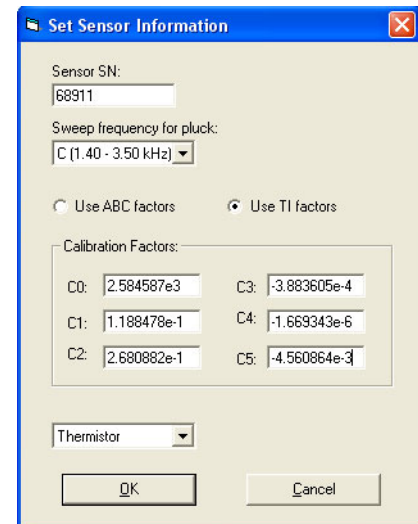

The screenshot shows the 'Set Sensor Information' dialog box. The 'Sensor SN' field contains '68911'. The 'Sweep frequency for pluck:' dropdown is set to 'C (1.40 - 3.50 kHz)'. The 'Use TI factors' radio button is selected. The 'Calibration Factors' section contains the following values: C0: 2.584587e3, C1: 1.188478e-1, C2: 2.680882e-1, C3: -3.883605e-4, C4: -1.669343e-6, C5: -4.560864e-3. The 'Thermistor' dropdown is selected. The 'OK' and 'Cancel' buttons are at the bottom.

Using TI Calibration Factors

Sensors and Sweeps

Locate your sensor by name or part number. Then find the appropriate sweep in the same row. In general, it is best to use the lowest sweep range that covers the sensor frequencies.

Sensor Name	Required Sweep
Crackmeter	Sweep C. If necessary, try sweep B.
Displacement Sensor, Extensometer	Sweep C. If necessary, try sweep B.
Jointmeter, Mass Concrete	Sweep C. If necessary, try sweep B.
Jointmeter, Submersible	Sweep C. If necessary, try sweep B.
Piezometer	Sweep C
Rebar Stressmeter	Sweep C. If necessary, try sweep B.
Settlement Cell, 20 psi	Sweep C. If necessary try sweep B.
Settlement Cell, 50 or 100 psi	Sweep C
Strain Gauge, Arc-Weldable	Sweep B. If necessary, try Sweep A
Strain Gauge, Embedment	Sweep B. If necessary try sweep A
Strain Gauge, Concrete Surfaces	Sweep B. If necessary, try Sweep A
Strain Gauge, Spot-Weldable	Sweep B for measuring compression Sweep C for measuring tension
Stress Station, VW Transducers	Sweep C
Total Pressure Cell	Sweep C
Total Pressure Cell, Radial	Sweep C
Total Pressure Cell, Tangential	Sweep C

Sweep Frequencies

If your sensor is not listed above, check your sensor calibration sheet to find the lowest and highest frequencies in the calibration. Then choose the sweep that is closest to those frequencies.

Sweep	Starting Freq	Ending Freq
Sweep A	450	1125
Sweep B	800	2000
Sweep C	1400	3500
Sweep D	2300	6000

Set Schedule

Click on the “Set Schedule” button to choose the start mode and reading interval. Then click OK.

Start Time: You can choose to have the MiniLogger start when batteries are inserted or you can choose a specific time to start.

If you choose “On power up,” the MiniLogger uses the moment that you insert the batteries as the base time for subsequent readings.

If you choose “At” and enter a time and date, the MiniLogger will use the time and date as the base time for subsequent readings.

The default start time is always 2 minutes in the future according to the MiniLogger’s clock. Edit this as needed, but be sure to specify a start time that is in the future.

Reading Interval: The reading interval controls how often readings are taken. For example, if you enter a 1 in the “hours” Hours field, the MiniLogger will take one reading every hour, with the first reading taken according to the Start Time setting. The shortest valid interval is 2 seconds. The longest is 7 days.

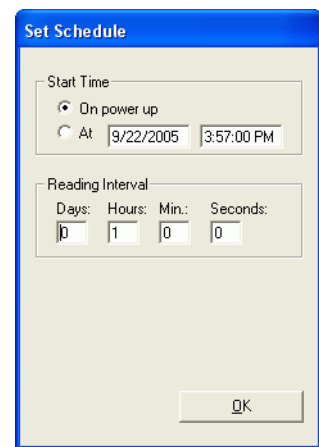

Set Clock

Click on the “Set Clock” button to set the MiniLogger’s clock. To synchronize the MiniLogger clock to your computer’s clock, click the “Match

Computer” button. If you want to set a different time, click in the date and time fields, type in values, and click OK.

Note 1: The date display format is controlled by the short date setting in Windows (Control Panel > Regional Settings > Date).

Note 2: Both the MiniLogger and the Manager program use four-digit years internally.

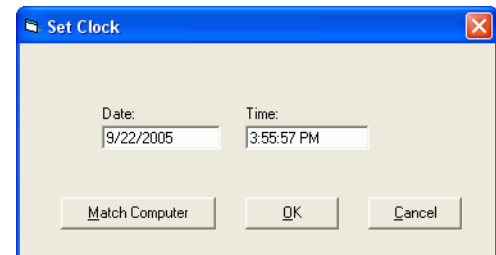

Data Logging

- Overview**
1. Connect the sensor to the MiniLogger.
 2. Insert new batteries, if necessary.
 3. Check the MiniLogger's settings.
 4. Verify operation using terminal mode (Optional).

- Connect the Sensor**
1. Remove the MiniLogger's lid.
 2. Prepare to insert cable through the cable gland: remove the nut, the nylon washer, and the rubber compression sleeve. Earlier models of the MiniLogger do not have the nylon washer. Slide the nut, nylon washer, and rubber compression sleeve onto the sensor's signal cable
 3. Insert the cable through the cable gland and connect the wires the MiniLogger's terminals as explained below.

Function	Wire Color	Alt Wire Color
VW	Orange	Red
VW	White & Orange	Black
Temperature	Blue	White
Temperature	White & Blue	Green
Shield (Drain)	Bare wire	Bare wire

4. Pull gently on the wires to check the connection.

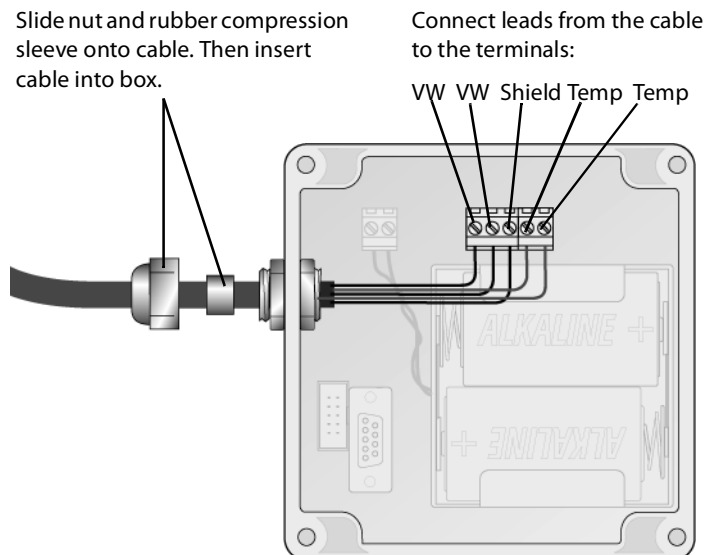

Insert Batteries

The MiniLogger requires two D-cell batteries. Battery life depends on how often readings are taken and also on the ambient temperature. Alkaline batteries normally provide about three months of service, but can last as long as six months. Cold temperatures and use of a radio will shorten battery life.

1. Check that wires from the battery holder are securely connected to the MiniLogger's terminal post.
2. Orient and insert the batteries as printed on the base of the battery holder.

Check Settings

1. Connect the MiniLogger to your PC.
2. Start the Manager program
3. Click on the Edit Settings Buttons
4. Observe the settings displayed on the control panel. Make any necessary modifications. Then click the Back button.

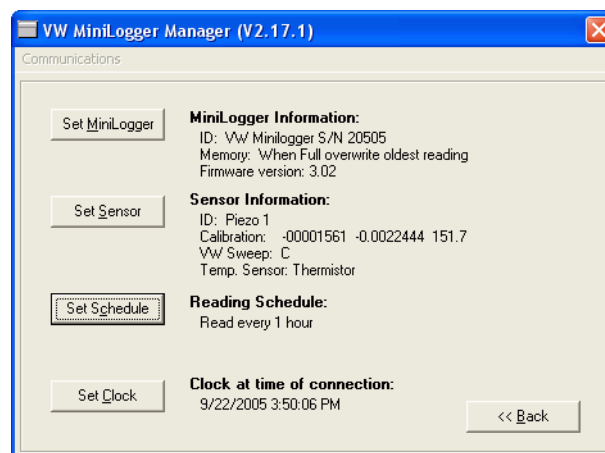

Retrieving Data

Retrieving Readings

The MiniLogger is not very speedy in transmitting data to the PC. Retrieval time increases with the number of stored readings. You can minimize retrieval times by regularly clearing the MiniLogger's memory after you collect the readings.

1. Connect the MiniLogger to your PC and start the Manager program.
2. Click "Retrieve Readings."

Click this button to retrieve readings.

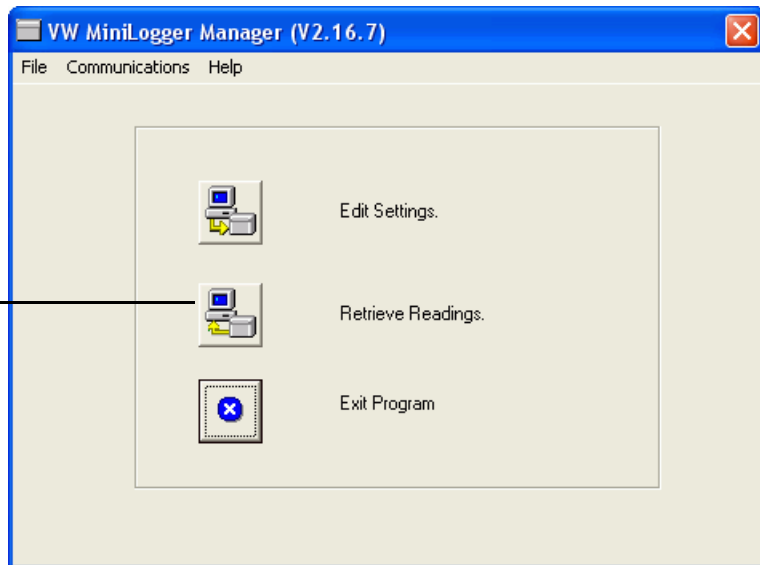

3. The MiniLogger reports its progress.

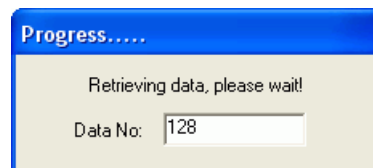

- The MiniLogger Manager displays time-stamped readings both in Hz and engineering units.

Click on Save to store the readings on your computer, as explained below.

Click on Erase to clear the MiniLogger's memory to make room for new readings.

DataNo	RecTime	Hz	EngineeringUnit	Temperature
1753	29-Feb-00 1:29:49 AM	3067.664	27.57952	19.69203
1754	29-Feb-00 1:29:51 AM	3067.701	27.55496	19.81264
1755	29-Feb-00 1:29:53 AM	3067.73	27.5356	19.69203
1756	29-Feb-00 1:29:55 AM	3067.833	27.46695	19.77262
1757	29-Feb-00 9:30:01 AM	3066.845	28.12519	20.69694
1758	29-Feb-00 10:10:01 AM	3066.723	28.2065	21.25749
1759	29-Feb-00 10:12:01 AM	3066.657	28.2504	21.37956
1760	29-Feb-00 10:27:01 AM	3066.751	28.1878	21.65821
1761	29-Feb-00 10:36:01 AM	3066.779	28.16909	21.66016
1762	29-Feb-00 10:41:01 AM	3066.704	28.21902	21.73926
1763	29-Feb-00 10:46:01 AM	3066.507	28.35024	21.81934
1764	29-Feb-00 11:59:01 AM	3066.61	28.28162	22.29785
1765	29-Feb-00 12:23:01 PM	3066.469	28.37561	21.9795
1766	29-Feb-00 12:28:01 PM	3066.469	28.37561	22.66162

- Click "Save" to display options for saving the readings. These options are explained on the next page.

Step 1: Choose a folder and a file name for the data.

Step 2: Choose all readings or a range of readings.

Step 3: Choose a format. The default .csv format is suitable for spreadsheets. The optional CR10 .dat format is useful when the MiniLogger is used to supplement a CR10 system.

Retrieving data from the MiniLogger does not erase the data from the MiniLogger. Be sure to erase the MiniLogger's memory.

Save readings to: 12123 [Browse...]

Save all readings.
 Save a range of readings.

Range:
 From: 10/17/2006 11:35:25 AM
 To: 10/17/2006 4:34:25 PM

Use CR10 format. Output array ID: 1

[Save] [Cancel]

Save readings to: Click the Browse button to specify a folder and a file name for the readings. Then click Save.

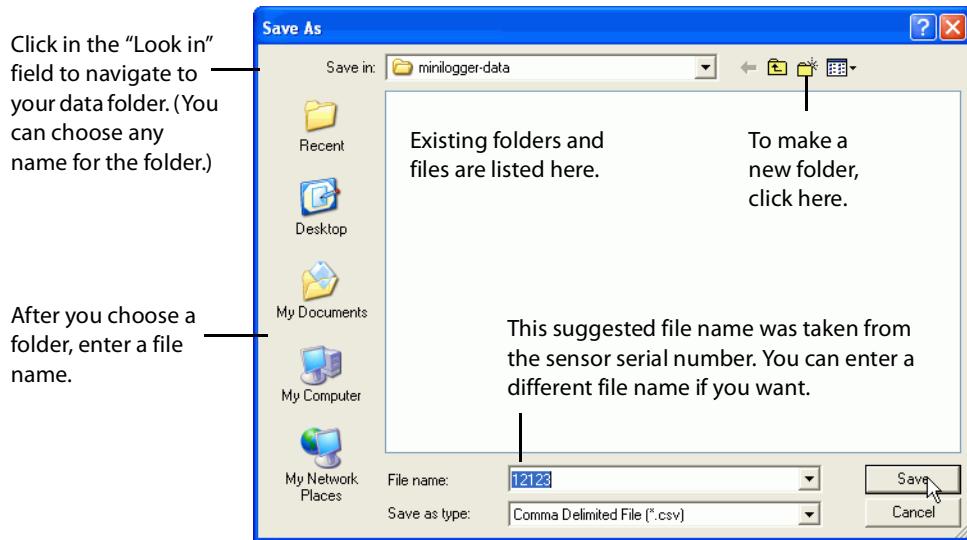

Retrieval Options Choose the range of readings that you want, the format (optional) and then click "Save."

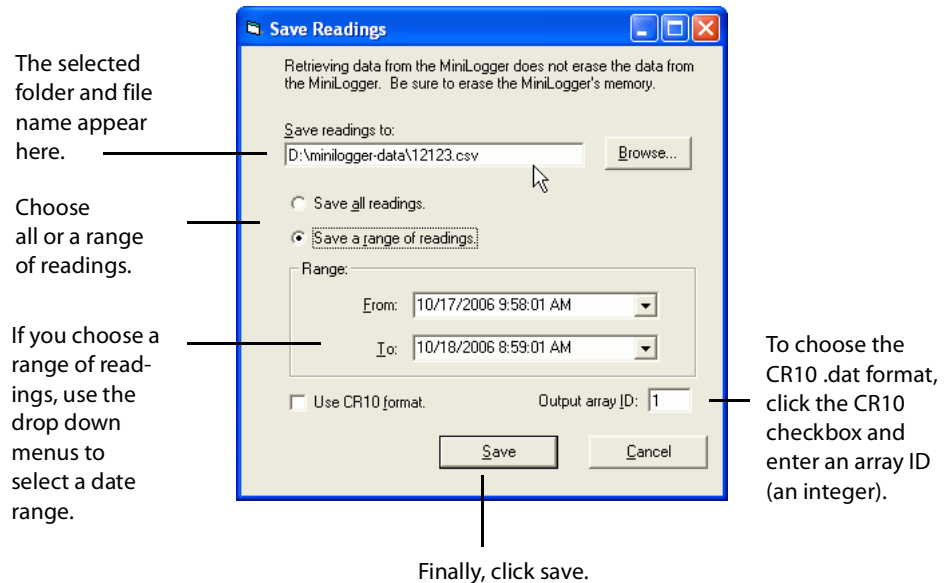

Erase This is an important last step. After you retrieve readings from the MiniLogger, you must clear the DataMate's memory to make room for new readings.

1. Using your spreadsheet program or an ASCII file editor such as Notepad, check that the readings are safely stored on disk.
2. Return to the Manager program, click "Readings," and click the "Erase" button. Then click OK to confirm.

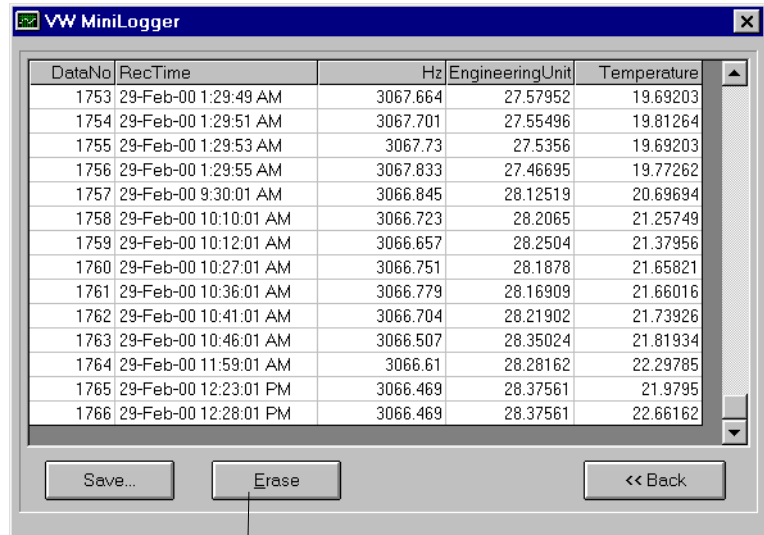

Click the "Erase" button, and then click OK to erase the readings in the MiniLogger.

About Radio MiniLoggers

Components The radio minilogger system includes these components:

**MiniLogger
with Wireless Option**

The wireless option is a 900 Mhz or 2.4 Ghz radio embedded in the lid of the MiniLogger. These 'radio lids' can be ordered with new MiniLoggers or retrofit to old MiniLoggers.

Each radio lid has a label with an ID and channel number. You will need the ID and channel number to make the wireless connection.

The radio lid replaces the standard lid of the MiniLogger. It is connected to the base of the MiniLogger by a cable. One end of the cable plugs into the MiniLogger's serial port. The other end of the cable plugs into the radio lid. An antenna screws into a terminal on the top of the lid.

Powering the radio naturally shortens battery life. Some testing has shown that when readings are taken at 1 hour intervals and retrieved four times a day, batteries can last three months or more in moderate weather. RF noise and longer distances from the logger will result in longer transmission times and shorten battery life.

Base Station Radio

The base station radio is connected to the PC via a USB cable. One end of the cable plugs into the radio and the other end of the cable plugs into a USB port on your PC.

The base station radio is powered through the USB cable. If you are using a portable PC, consider that its battery will be powering the radio as well as the PC itself. If you are away from mains power, you may find it necessary to buy a car charger for the PC.

Base Station Software

You must install driver software to make the base station work with your computer. You can find this software on a CD supplied with the base station. The next chapter tells how to install the software.

Installing Base Station Software

Installing the Base Station Drivers

The base station drivers are on a CD that was supplied with the radio. The installation process is simple, but it may surprise you. Two drivers must be installed, and when you finish installing the first driver, installation of the second one begins. It may seem as if you are repeating the same process, but in fact, you are installing a second driver. Follow the steps below:

1. Start your PC.

Connect the base station radio to the PC using the USB cable. The PC displays an installation wizard.

Choose “No, not this time” and then click Next.



2. Now choose “Install from a list or specific location” and click Next.

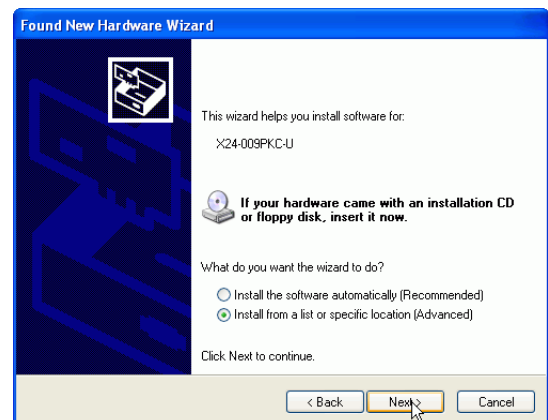

Installing the drivers
continued

3. Now choose Search, click the checkbox for “Search removable media.” Insert the CD and click Next.

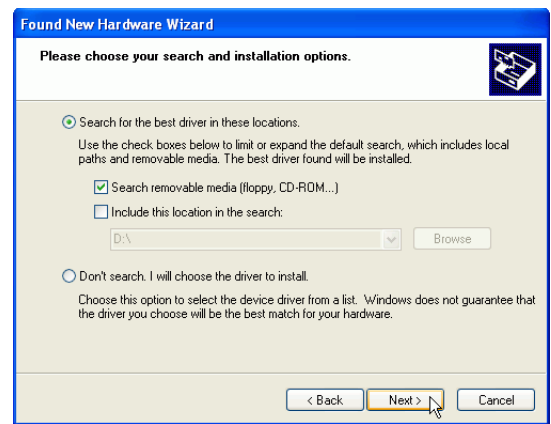

4. After a few seconds, the CD may pop up a startup screen. If this happens, click the exit button to close the screen.



Click exit if you see this screen.

5. Windows searches for the driver, installs it, and displays this screen. Click Finish and go to the next step, which installs the second driver.

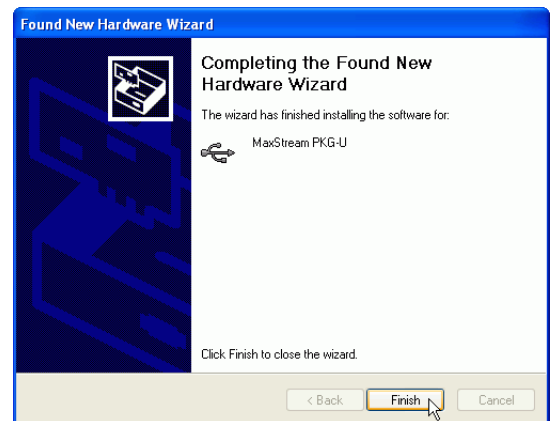

6. Now Windows starts a wizard to install the second driver.

Choose “No, not this time” and click Next.



7. Now, choose “Install from a list or specific location,” and click Next.

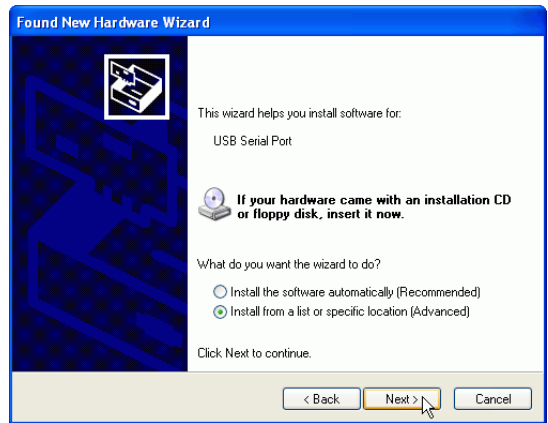

8. Windows is done. Click Finish.

Now you can use the base station.

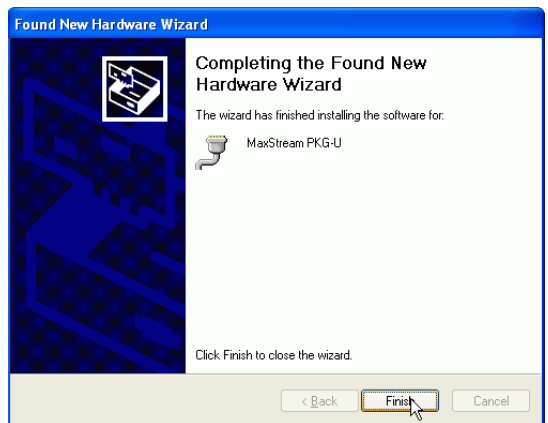

Entering Radio IDs

Introduction The Manager program needs a list of the radio IDs of the loggers that you want to connect to. This chapter tells how to create the list.

- Selecting the Comm Port**
1. Connect the base station to the PC, and start the MiniLogger Manager program.
 2. Click “Communications” to display the Communications Setup dialog.
 3. Refresh the list of Comm ports, then choose one. Try the highest number first.

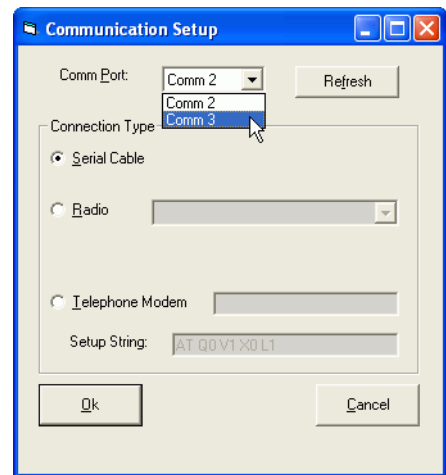

- Enter Radio IDs**
1. Choose Radio. Click in the blank field to the right. Choose Edit List.

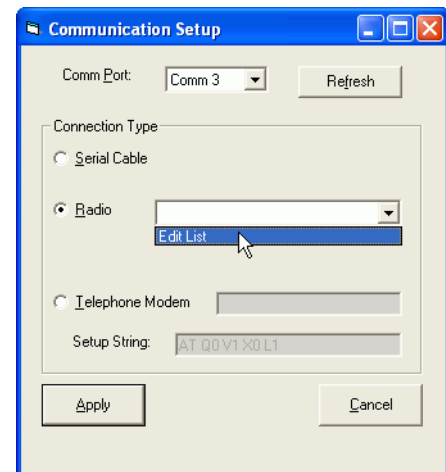

2. Click Add to add a radio ID.

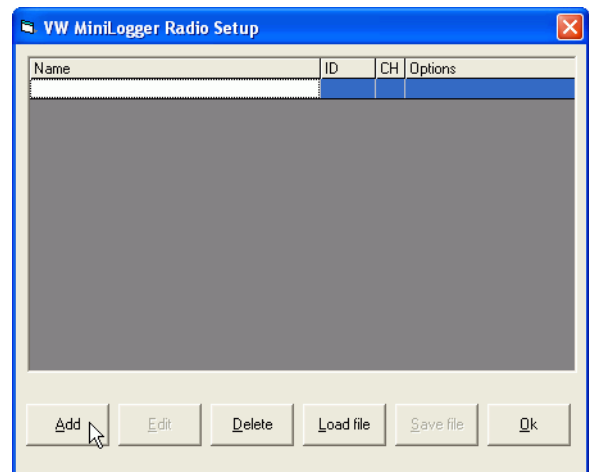

3. When the dialog pops up, enter a name, ID, and channel. Then click OK.

The name can be any convenient name for the logger.

The ID and Channel must be taken from the label on the Radio Lid.



4. Click Save to store the list on your computer.



-
5. You can specify a folder for the list of radio IDs. The list is a text file named “Radiolst.lst.” You can specify a different name and a different folder for this file. You can also copy this file to other computers as needed.

In this example, we made a folder called “minilogger-data” and will store the list in that folder. The Manager program remembers the last file and folder used.



6. Add more addresses to your list as needed. Be sure to click Save each time you add an address.

Now you can use the base station with your Radio MiniLoggers.

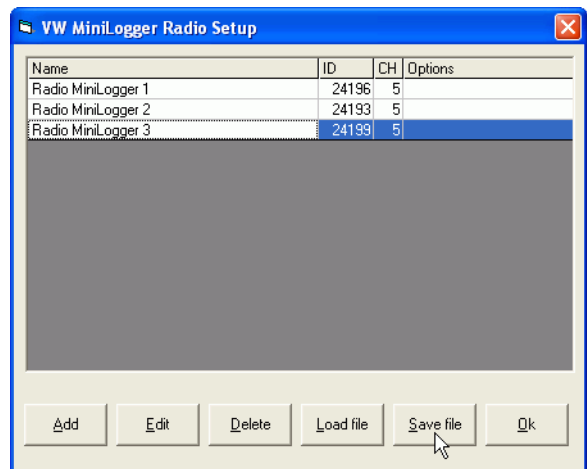

Connecting to Radio MiniLogger

Introduction The instructions below tell how to establish the connection between your PC and the Radio MiniLogger. Once the connection is established, the Manager program works just as if you were using a serial cable.

1. Connect the base station to your PC, start the Manager Program, and choose Communications.

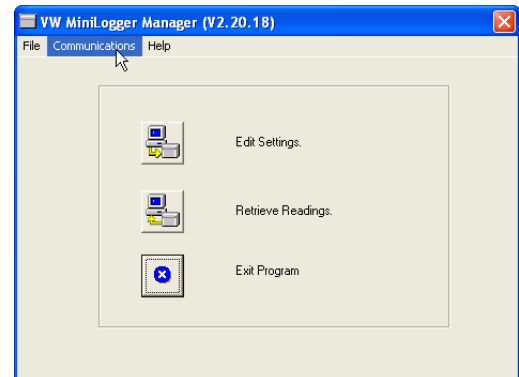

2. Select a Radio Logger from the Radio ID list and click Apply.

If you don't see a list, it was probably renamed, moved, or copied from a different computer. Click Edit List. Then click the Load button to load the list.

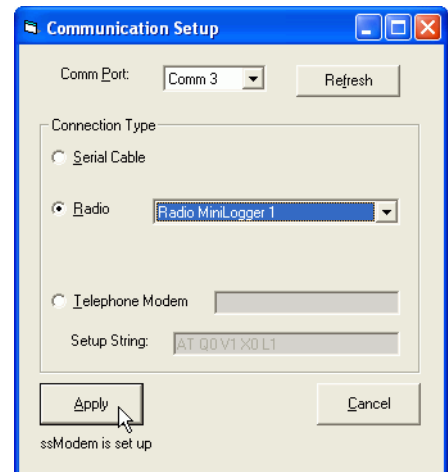

3. When a connection is made, you see the main menu.

Now you can work with the MiniLogger as if you were connected by cable.

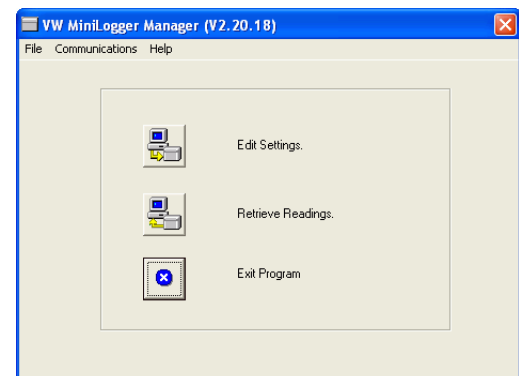

4. When you are done with the first logger, you come back to this screen. To connect to another logger, choose communications.

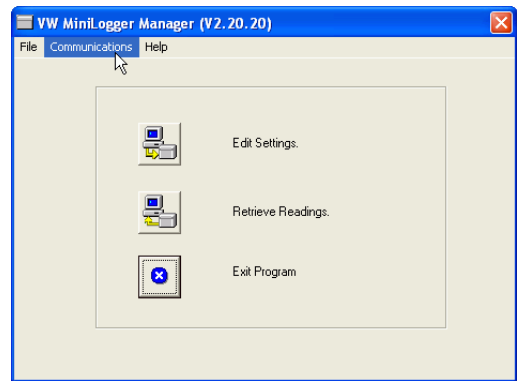

5. Then choose the logger from the list and click Apply.

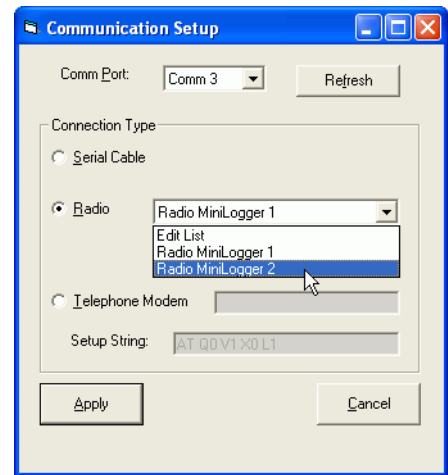

6. The main menu appears again when you are connected.

